

MUGEN COATING PREMIUM Plus
2-Flute Long Neck Ball End Mill with Short Shank
for Hardened Steel and High accuracy cutting

MRBSH230SF **Size Expansion**

32 sizes added
Total 115 sizes

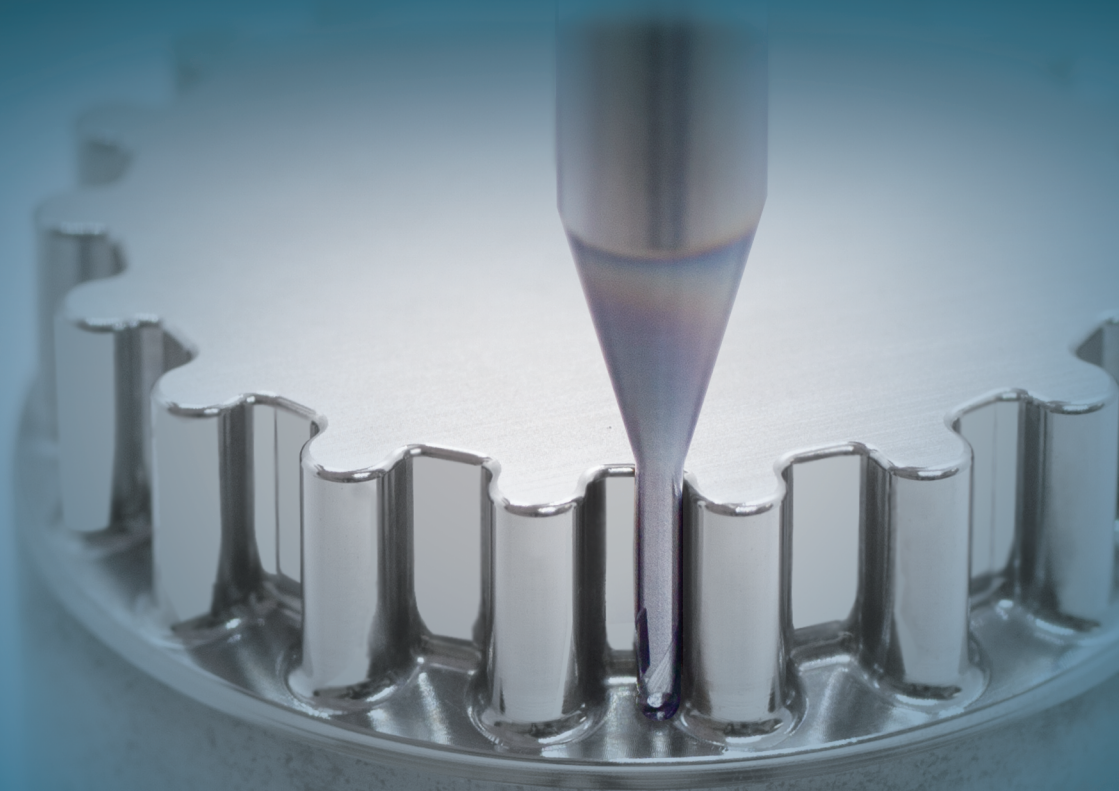

High precision and long tool life even for hardened steel up to 70 HRC

MRBSH230SF

R0.05 ~ R3 Total 115 sizes

Achieves long tool life and high precision cutting even for 70HRC hardened steel



R accuracy is based on a half value of actual diameter

Features

Total 115 sizes include new addition 32 sizes realize abundant line up variations of under neck length



Coating

1	New coating MUGEN COATING PREMIUM Plus with high Oxidation resistance and abrasion resistance
----------	---

Introduced in the previous page

Shape

2-1	Cutting edge shape with reduced cutting load
2-2	Achieves high rigidity with optimal tool overhung High accuracy precision shank supported shrink fit chuck
2-3	Highly accurate R shape that is smooth and seamless

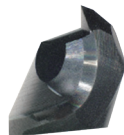

Tolerance range
0.002 mm

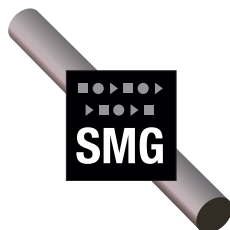
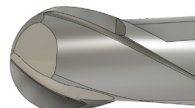

Material

3	Super micro grain carbide with improved fracture resistance
----------	---

Feature
1

Long tool life

Coating MUGEN COATING PREMIUM Plus

MUGEN COATING PREMIUM Plus is suitable for machining above 60HRC
Demonstrates same performance with MUGEN COATING PREMIUM even on machining 45 ~ 60HRC

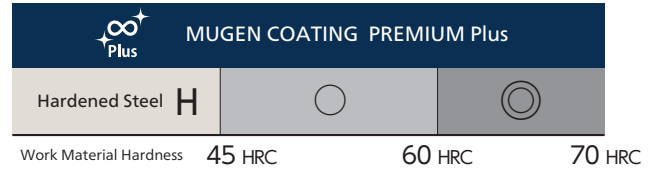

Comparison of dimensional accuracy

HAP72 (70HRC)
Comparison of dimensional accuracy after roughing
Tool : MRBSH230SF R1x6
Cutting content:
Roughing contour lines for 4 pockets
Stock : 0.02mm
Target : 7.960mm
Cutting time : 20min/per pocket
Tool path : Roughing contour line

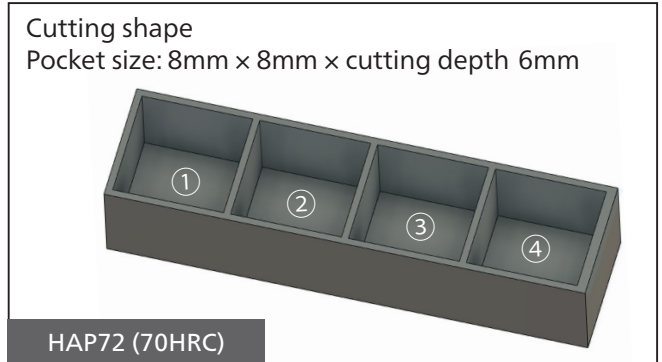
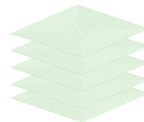

Roughing

$n = 16,000 \text{min}^{-1}$, $V_f = 1,200 \text{mm/min}$, $a_p 0.1 \times a_e 0.3 \text{mm}$, Oil Mist

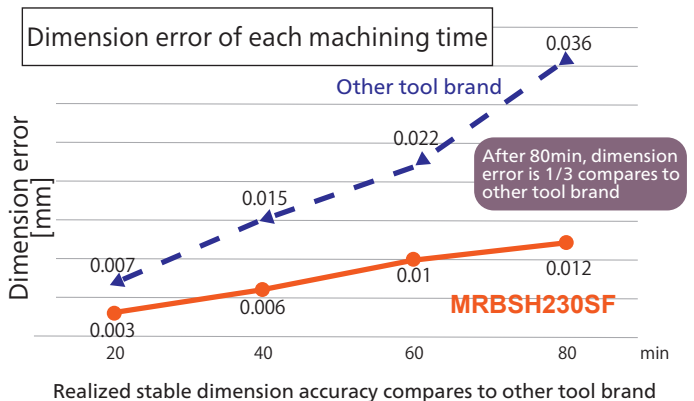
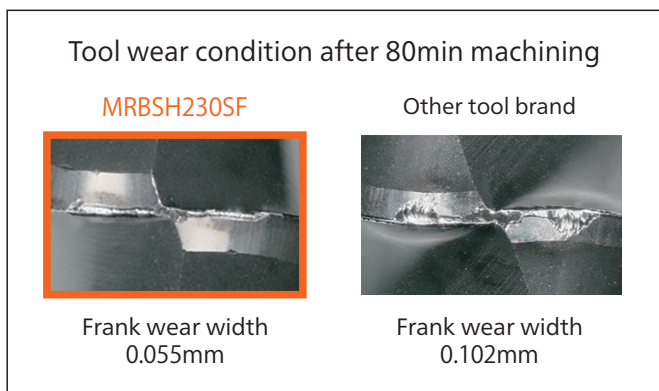

High precision and long tool life even for hardened steel up to 70 HRC

Feature 2-1 Improved machinability Shape Cutting edge

Sharp cutting edge with reduced cutting load and new material with fracture resistance realizes long tool life and high precision for hardened steel

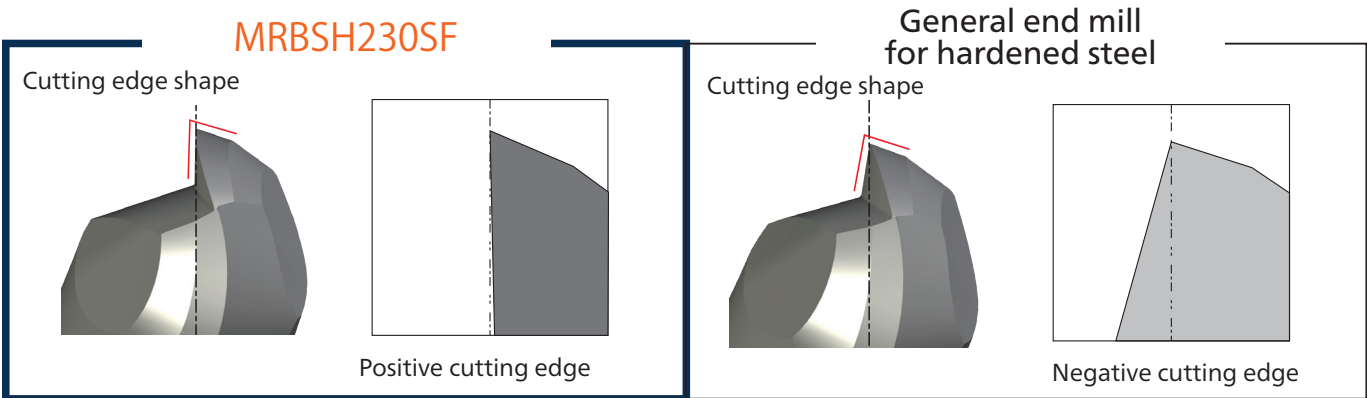

Cutting load is reduced by positive cutting edge and by adopting a new material Super micro grain carbide prevent chipping even with hardened steel. Negative cutting edge shape with high cutting load

Feature 2-2 Improved cutting accuracy Shape Optimal overhung length

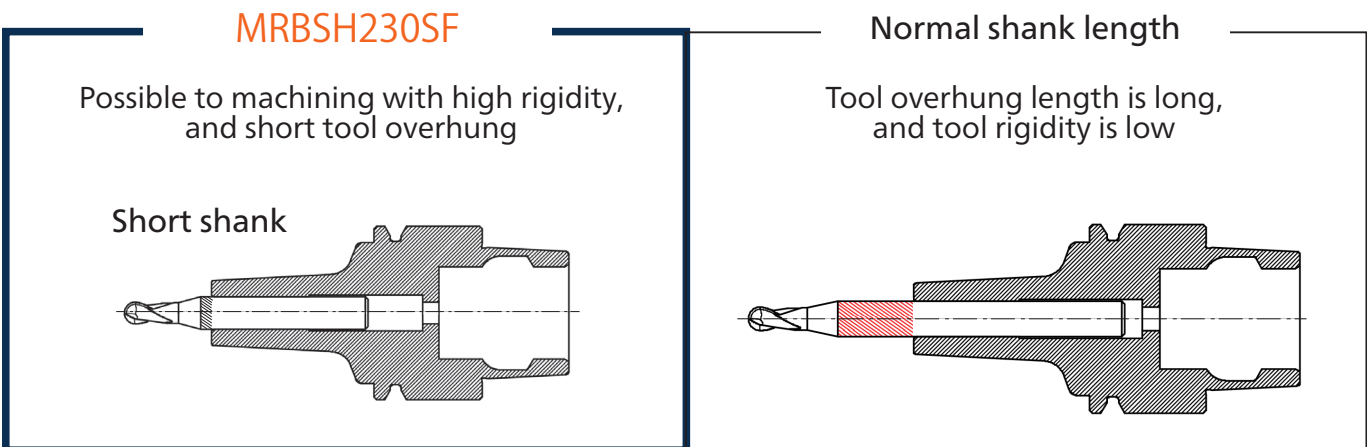

Feature 2-2 Compatible with high accuracy shrink-fit chuck Shape High accuracy shank



Feature
2-3

High accuracy R

Shape Highly accurate R

Seamless design on rake face and flank face from R-curve to peripheral cutting edge realized high precision R accuracy

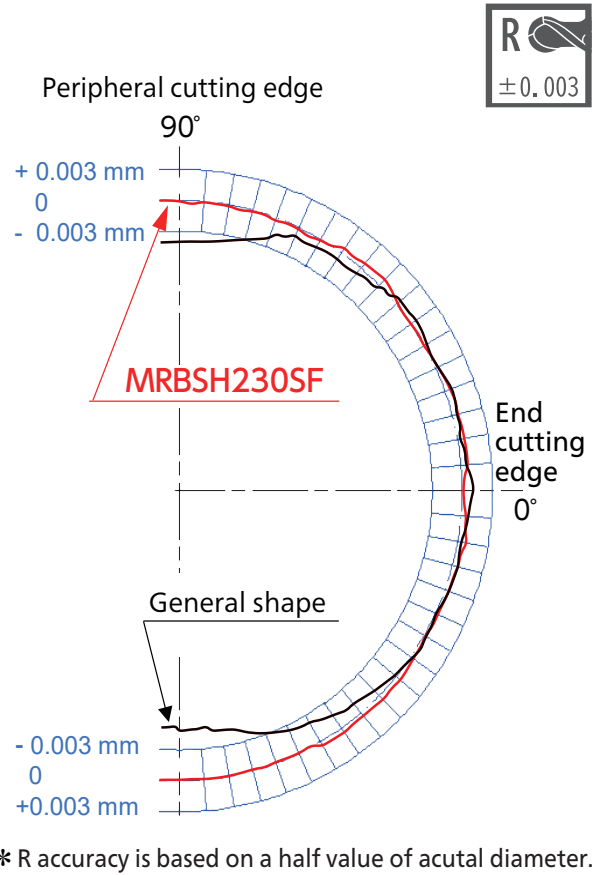
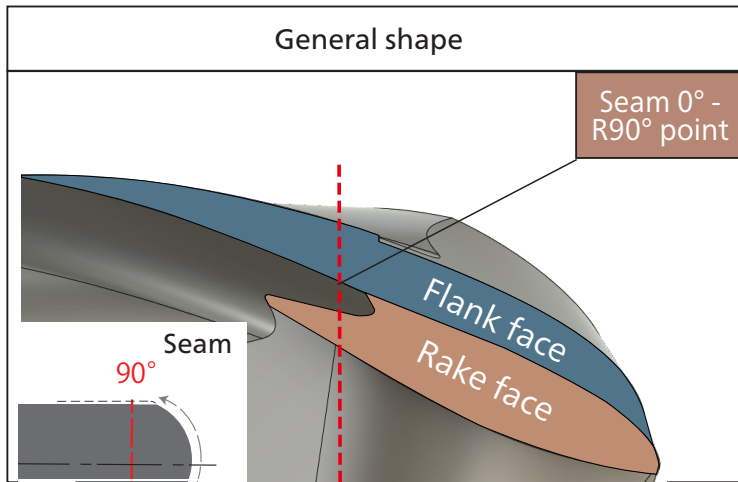
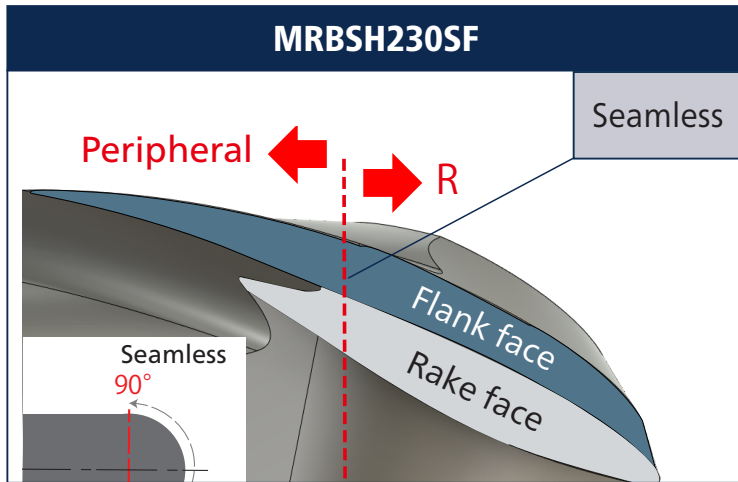

Feature
3

Upgrade abrasion ability

Material Carbide material



New material adopted 「**Super micro grain carbide**」 to specialize abrasion resistance and fracture resistance.

High precision and long tool life even for hardened steel up to 70 HRC

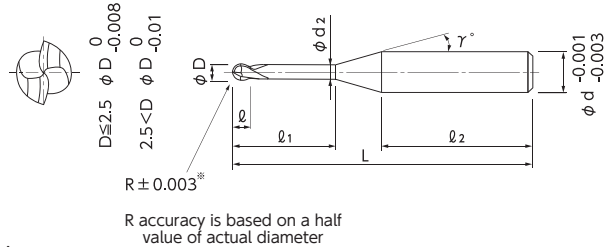

- Realize stable cutting performance even for 70 HRC hardened steels.
- Developed new MUGEN COATING PREMIUM Plus to upgrade oxidation resistance and abrasion resistance.
- Adopt optimized new tool material and tool design to reduce cutting load.
- R accuracy is $\pm 0.003\text{mm}$ (R accuracy is based on a half value of actual diameter).
- Shank diameter tolerance, high accuracy type, is $-0.001 \sim -0.003$.

Work Material

Hardened Steel H	
45~60HRC	60~70HRC
○	◎

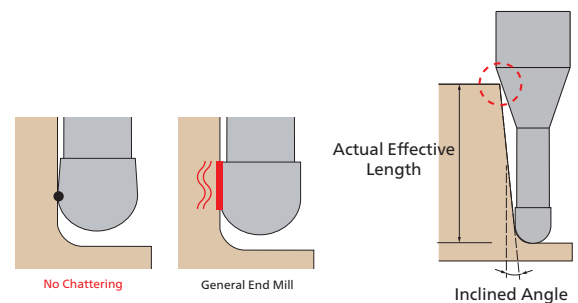

◆ Released in Oct, 2023.

Unit [Size : mm]

Code No.	Radius (R)	Under Neck Length (ℓ1)	Length of Cut (ℓ)	Dia. (D)	Neck Dia. (d2)	Neck Taper Angle (γ)	Shank Dia. (d)	Shank Length (ℓ2)	Overall Length (L)	Actual effective length depending on inclined angle of workpiece				
										30°	1°	1°30'	2°	3°
08-00537-00052	R0.05	0.2	0.07	0.1	0.085	15°	4	27.4	35	0.23	0.24	0.24	0.25	0.27
◆ 08-00537-00056		0.25	0.07	0.1	0.085	15°	4	27.4	35	0.28	0.29	0.30	0.31	0.33
08-00537-00053		0.3	0.07	0.1	0.085	15°	4	27.3	35	0.33	0.34	0.35	0.36	0.39
◆ 08-00537-00054		0.4	0.07	0.1	0.085	15°	4	27.2	35	0.44	0.45	0.46	0.48	0.52
08-00537-00055		0.5	0.07	0.1	0.085	15°	4	27.1	35	0.54	0.56	0.57	0.59	0.64
◆ 08-00537-00076	R0.075	0.25	0.1	0.15	0.13	15°	4	27.5	35	0.29	0.30	0.31	0.31	0.33
08-00537-00072		0.3	0.1	0.15	0.13	15°	4	27.4	35	0.34	0.35	0.36	0.37	0.40
◆ 08-00537-00077		0.4	0.1	0.15	0.13	15°	4	27.3	35	0.44	0.46	0.47	0.49	0.52
08-00537-00073		0.5	0.1	0.15	0.13	15°	4	27.2	35	0.55	0.56	0.58	0.60	0.65
◆ 08-00537-00074		0.6	0.1	0.15	0.13	15°	4	27.1	35	0.65	0.67	0.69	0.72	0.77
◆ 08-00537-00075	0.7	0.1	0.15	0.13	15°	4	27.0	35	0.75	0.78	0.80	0.83	0.89	
08-00537-00101	R0.1	0.3	0.15	0.2	0.18	15°	4	27.5	35	0.34	0.35	0.36	0.37	0.39
◆ 08-00537-00106		0.4	0.15	0.2	0.18	15°	4	27.4	35	0.44	0.46	0.47	0.48	0.51
08-00537-00102		0.5	0.15	0.2	0.18	15°	4	27.3	35	0.55	0.56	0.58	0.60	0.64
◆ 08-00537-00107		0.6	0.15	0.2	0.18	15°	4	27.2	35	0.65	0.67	0.69	0.71	0.76
08-00537-00103		0.75	0.15	0.2	0.18	15°	4	27.1	35	0.81	0.83	0.86	0.89	0.95
◆ 08-00537-00104	0.85	0.15	0.2	0.18	15°	4	27.0	35	0.91	0.94	0.97	1.00	1.07	
08-00537-00105	1	0.15	0.2	0.18	15°	4	26.8	35	1.06	1.10	1.13	1.17	1.26	
08-00537-00150	R0.15	0.5	0.2	0.3	0.28	15°	4	27.5	35	0.55	0.56	0.57	0.59	0.63
08-00537-00151		0.6	0.2	0.3	0.28	15°	4	27.4	35	0.65	0.67	0.69	0.71	0.75
08-00537-00152		0.75	0.2	0.3	0.28	15°	4	27.3	35	0.80	0.83	0.85	0.88	0.94
08-00537-00153		1	0.2	0.3	0.28	15°	4	27.0	35	1.06	1.09	1.13	1.17	1.25
◆ 08-00537-00154		1.25	0.2	0.3	0.28	15°	4	26.8	35	1.32	1.36	1.41	1.45	1.56
08-00537-00155	1.5	0.2	0.3	0.28	15°	4	26.5	35	1.58	1.63	1.68	1.74	1.87	
08-00537-00201	R0.2	0.5	0.3	0.4	0.37	15°	4	27.7	35	0.56	0.58	0.59	0.60	0.64
◆ 08-00537-00207		0.65	0.3	0.4	0.37	15°	4	27.6	35	0.72	0.74	0.76	0.78	0.83
08-00537-00202		0.8	0.3	0.4	0.37	15°	4	27.4	35	0.87	0.90	0.92	0.95	1.01

How to Order

When you order, indicate MRBSH230SF (R)×(ℓ1).

※(γ) is reference value.

Unit [Size : mm]

Code No.	Radius (R)	Under Neck Length (ℓ ₁)	Length of Cut (ℓ)	Dia. (D)	Neck Dia. (d ₂)	Neck Taper Angle (γ)	Shank Dia. (d)	Shank Length (ℓ ₂)	Overall Length (L)	Actual effective length depending on inclined angle of workpiece				
										30°	1°	1°30′	2°	3°
08-00537-00203	R0.2	1	0.3	0.4	0.37	15°	4	27.2	35	1.08	1.11	1.14	1.18	1.26
◆ 08-00537-00208		1.25	0.3	0.4	0.37	15°	4	27.0	35	1.34	1.38	1.42	1.47	1.57
08-00537-00204		1.5	0.3	0.4	0.37	15°	4	26.7	35	1.60	1.65	1.70	1.75	1.88
◆ 08-00537-00209		1.75	0.3	0.4	0.37	15°	4	26.5	35	1.86	1.91	1.98	2.04	2.19
08-00537-00205		2	0.3	0.4	0.37	15°	4	26.2	35	2.11	2.18	2.25	2.33	2.50
◆ 08-00537-00210		2.25	0.3	0.4	0.37	15°	4	26.0	35	2.37	2.45	2.53	2.62	2.81
08-00537-00206		2.5	0.3	0.4	0.37	15°	4	25.7	35	2.63	2.72	2.81	2.90	3.13
◆ 08-00537-00251	R0.25	0.5	0.35	0.5	0.46	15°	4	27.8	35	0.58	0.59	0.61	0.62	0.65
08-00537-00252		1	0.35	0.5	0.46	15°	4	27.3	35	1.10	1.13	1.16	1.19	1.27
08-00537-00253		1.5	0.35	0.5	0.46	15°	4	26.8	35	1.61	1.66	1.71	1.77	1.89
08-00537-00254		2	0.35	0.5	0.46	15°	4	26.3	35	2.13	2.20	2.27	2.34	2.51
08-00537-00255		2.5	0.35	0.5	0.46	15°	4	25.8	35	2.65	2.73	2.82	2.92	3.14
08-00537-00256		3	0.35	0.5	0.46	15°	4	25.3	35	3.16	3.27	3.38	3.49	3.76
◆ 08-00537-00307	R0.3	0.6	0.45	0.6	0.56	15°	4	27.9	35	0.68	0.70	0.71	0.73	0.76
08-00537-00300		1	0.45	0.6	0.56	15°	4	27.5	35	1.10	1.12	1.15	1.19	1.26
08-00537-00301		1.5	0.45	0.6	0.56	15°	4	27.0	35	1.61	1.66	1.71	1.76	1.88
08-00537-00302		2	0.45	0.6	0.56	15°	4	26.5	35	2.13	2.19	2.26	2.34	2.50
08-00537-00303		2.5	0.45	0.6	0.56	15°	4	26.0	35	2.65	2.73	2.82	2.91	3.12
08-00537-00304		3	0.45	0.6	0.56	15°	4	25.5	35	3.16	3.26	3.37	3.49	3.75
08-00537-00305		3.5	0.45	0.6	0.56	15°	4	25.0	35	3.68	3.80	3.92	4.06	4.37
08-00537-00306		4	0.45	0.6	0.56	15°	4	29.5	40	4.20	4.33	4.48	4.64	4.99
◆ 08-00537-00401	R0.4	1	0.6	0.8	0.76	15°	4	27.9	35	1.09	1.12	1.14	1.17	1.24
08-00537-00402		2	0.6	0.8	0.76	15°	4	26.9	35	2.13	2.19	2.25	2.32	2.48
08-00537-00403		3	0.6	0.8	0.76	15°	4	25.9	35	3.16	3.26	3.36	3.47	3.72
08-00537-00405		4	0.6	0.8	0.76	15°	4	24.9	35	4.19	4.33	4.47	4.62	4.97
08-00537-00406		5	0.6	0.8	0.76	15°	4	28.9	40	5.23	5.40	5.58	5.77	6.21
◆ 08-00537-00507		R0.5	1	0.75	1	0.95	15°	4	28.3	35	1.11	1.13	1.15	1.18
◆ 08-00537-00508	1.5		0.75	1	0.95	15°	4	27.8	35	1.63	1.66	1.71	1.75	1.86
08-00537-00501	2		0.75	1	0.95	15°	4	27.3	35	2.14	2.20	2.26	2.33	2.48
08-00537-00502	2.5		0.75	1	0.95	15°	4	26.8	35	2.66	2.73	2.82	2.90	3.10
08-00537-00503	3		0.75	1	0.95	15°	4	26.3	35	3.18	3.27	3.37	3.48	3.72
08-00537-00504	4		0.75	1	0.95	15°	4	25.3	35	4.21	4.34	4.48	4.63	4.97
08-00537-00505	5		0.75	1	0.95	15°	4	29.3	40	5.24	5.41	5.59	5.78	6.21
08-00537-00506	6		0.75	1	0.95	15°	4	28.3	40	6.28	6.48	6.69	6.93	7.45
08-00537-00602	R0.6	2.4	0.9	1.2	1.15	15°	4	27.2	35	2.55	2.62	2.69	2.77	2.95
08-00537-00603		4	0.9	1.2	1.15	15°	4	25.6	35	4.21	4.33	4.47	4.61	4.94
08-00537-00605		6	0.9	1.2	1.15	15°	4	28.6	40	6.27	6.47	6.68	6.91	7.43
08-00537-00606		8	0.9	1.2	1.15	15°	4	26.6	40	8.34	8.61	8.90	9.21	9.91
◆ 08-00537-00751	R0.75	2	1.1	1.5	1.45	15°	4	28.2	35	2.13	2.18	2.23	2.29	2.42
08-00537-00752		3	1.1	1.5	1.45	15°	4	27.2	35	3.17	3.25	3.34	3.44	3.66
08-00537-00753		4	1.1	1.5	1.45	15°	4	26.2	35	4.20	4.32	4.45	4.59	4.91
08-00537-00754		6	1.1	1.5	1.45	15°	4	29.2	40	6.27	6.46	6.67	6.89	7.39
08-00537-00755		8	1.1	1.5	1.45	15°	4	27.2	40	8.34	8.60	8.88	9.19	9.88
08-00537-00756		10	1.1	1.5	1.45	15°	4	25.2	40	10.40	10.74	11.10	11.49	12.36
08-00537-00805	R0.8	8	1.2	1.6	1.55	15°	4	27.4	40	8.33	8.60	8.88	9.18	9.87
◆ 08-00537-00901	R0.9	3	1.3	1.8	1.74	15°	4	27.8	35	3.18	3.26	3.35	3.44	3.65
◆ 08-00537-00902		4	1.3	1.8	1.74	15°	4	26.8	35	4.22	4.33	4.46	4.59	4.89
◆ 08-00537-00903		6	1.3	1.8	1.74	15°	4	29.8	40	6.28	6.47	6.67	6.89	7.38
◆ 08-00537-00904		8	1.3	1.8	1.74	15°	4	27.8	40	8.35	8.61	8.89	9.19	9.87
◆ 08-00537-00905		10	1.3	1.8	1.74	15°	4	25.8	40	10.42	10.75	11.11	11.49	12.35
◆ 08-00537-01006	R1	2	1.5	2	1.94	15°	4	29.1	35	2.14	2.19	2.23	2.28	2.38
08-00537-01000		3	1.5	2	1.94	15°	4	28.1	35	3.18	3.25	3.34	3.43	3.63
08-00537-01001		4	1.5	2	1.94	15°	4	27.1	35	4.21	4.32	4.45	4.58	4.87
08-00537-01002		6	1.5	2	1.94	15°	4	25.1	35	6.28	6.46	6.66	6.88	7.36

MUGEN COATING PREMIUM Plus

2-Flute Long Neck Ball End Mill with Short Shank for Hardened Steel and High accuracy cutting

◆ Released in Oct, 2023.

Unit [Size : mm]

Code No.	Radius (R)	Under Neck Length (ℓ1)	Length of Cut (ℓ)	Dia. (D)	Neck Dia. (d2)	Neck Taper Angle (γ)	Shank Dia. (d)	Shank Length (ℓ2)	Overall Length (L)	Actual effective length depending on inclined angle of workpiece				
										30°	1°	1°30′	2°	3°
08-00537-01003	R1	8	1.5	2	1.94	15°	4	28.1	40	8.35	8.60	8.88	9.18	9.84
08-00537-01004		10	1.5	2	1.94	15°	4	26.1	40	10.41	10.74	11.10	11.48	12.33
08-00537-01005		12	1.5	2	1.94	15°	4	29.1	45	12.48	12.88	13.31	13.77	14.82
◆ 08-00537-01251	R1.25	4	2.3	2.5	2.4	15°	4	28.0	35	4.28	4.39	4.50	4.62	4.90
08-00537-01252		6	2.3	2.5	2.4	15°	4	26.0	35	6.35	6.53	6.72	6.92	7.39
08-00537-01253		8	2.3	2.5	2.4	15°	4	29.0	40	8.42	8.67	8.93	9.22	9.88
08-00537-01254		10	2.3	2.5	2.4	15°	4	27.0	40	10.48	10.81	11.15	11.52	12.36
08-00537-01256		15	2.3	2.5	2.4	15°	4	27.0	45	15.65	16.15	16.69	17.27	Free
08-00537-01500		R1.5	6	2.5	3	2.85	15°	6	33.1	45	6.44	6.61	6.79	7.00
08-00537-01501	8		2.5	3	2.85	15°	6	31.1	45	8.50	8.75	9.01	9.29	9.93
08-00537-01502	10		2.5	3	2.85	15°	6	29.1	45	10.57	10.89	11.23	11.59	12.42
08-00537-01503	12		2.5	3	2.85	15°	6	27.1	45	12.64	13.03	13.44	13.89	14.91
08-00537-01504	14		2.5	3	2.85	15°	6	30.1	50	14.71	15.17	15.66	16.19	17.39
08-00537-01505	16		2.5	3	2.85	15°	6	28.1	50	16.77	17.31	17.88	18.49	19.88
◆ 08-00537-01507	18		2.5	3	2.85	15°	6	31.1	55	18.84	19.45	20.09	20.79	22.36
08-00537-01506	20		2.5	3	2.85	15°	6	29.1	55	20.91	21.58	22.31	23.09	24.85
08-00537-02000	R2		8	3	4	3.8	15°	6	32.8	45	8.58	8.81	9.06	9.33
08-00537-02001		10	3	4	3.8	15°	6	30.8	45	10.65	10.95	11.28	11.63	12.42
08-00537-02002		12	3	4	3.8	15°	6	28.8	45	12.72	13.09	13.49	13.93	14.90
08-00537-02004		15	3	4	3.8	15°	6	30.8	50	15.82	16.30	16.82	17.38	18.63
08-00537-02005		20	3	4	3.8	15°	6	30.8	55	20.99	21.65	22.36	23.13	Free
08-00537-02006		25	3	4	3.8	15°	6	30.8	60	26.16	27.00	27.90	28.88	Free
08-00537-02502	R2.5	10	3.5	5	4.8	15°	6	32.7	45	10.63	10.92	11.22	11.55	Free
08-00537-02503		15	3.5	5	4.8	15°	6	27.7	45	15.80	16.27	16.77	Free	Free
08-00537-02504		20	3.5	5	4.8	15°	6	27.7	50	20.97	21.62	Free	Free	Free
◆ 08-00537-02505		25	3.5	5	4.8	15°	6	27.7	55	26.14	26.96	Free	Free	Free
◆ 08-00537-02506		30	3.5	5	4.8	15°	6	27.7	60	31.31	Free	Free	Free	Free
08-00537-03000	R3	10	6	6	5.7	-	6	34.4	45	Free	Free	Free	Free	Free
08-00537-03001		15	6	6	5.7	-	6	29.4	45	Free	Free	Free	Free	Free
08-00537-03002		20	6	6	5.7	-	6	29.4	50	Free	Free	Free	Free	Free
08-00537-03003		25	6	6	5.7	-	6	29.4	55	Free	Free	Free	Free	Free
08-00537-03004		30	6	6	5.7	-	6	29.4	60	Free	Free	Free	Free	Free
◆ 08-00537-03005		35	6	6	5.7	-	6	29.4	65	Free	Free	Free	Free	Free
◆ 08-00537-03006		40	6	6	5.7	-	6	29.4	70	Free	Free	Free	Free	Free

How to Order

When you order, indicate MRBSH230SF (R)×(ℓ1).

※(γ) is reference value.

Work Material			High Speed Steels/Hardened Steels SKH51·SKD11 (~62HRC)				High Speed Steels SKH55·HAP40 (~66HRC)				High Speed Steels SKH57·HAP72 (~70HRC)			
Radius	Under Neck Length	L/D	Depth of Cut		Feed	Spindle Speed	Depth of Cut		Feed	Spindle Speed	Depth of Cut		Feed	Spindle Speed
			a _p mm	a _e mm	mm/min	min ⁻¹	a _p mm	a _e mm	mm/min	min ⁻¹	a _p mm	a _e mm	mm/min	min ⁻¹
R0.05	0.2	2	0.002	0.005	100	40,000	0.002	0.003	70	40,000	0.002	0.003	50	40,000
	0.25	2.5	0.002	0.005	80	40,000	0.002	0.003	50	40,000	0.002	0.003	40	40,000
	0.3	3	0.002	0.005	70	40,000	0.002	0.003	50	40,000	0.002	0.003	40	40,000
	0.4	4	0.001	0.005	70	40,000	0.001	0.003	50	40,000	0.001	0.002	30	40,000
	0.5	5	0.001	0.003	50	40,000	0.001	0.002	30	40,000	0.001	0.002	20	40,000
R0.075	0.25	1.7	0.002	0.005	160	40,000	0.002	0.003	120	40,000	0.002	0.003	100	40,000
	0.3	2	0.002	0.005	150	40,000	0.002	0.003	100	40,000	0.002	0.003	80	40,000
	0.4	2.7	0.002	0.005	120	40,000	0.002	0.003	70	40,000	0.002	0.003	50	40,000
	0.5	3.3	0.002	0.005	120	40,000	0.002	0.003	70	40,000	0.002	0.003	50	40,000
	0.6	4	0.001	0.003	100	40,000	0.001	0.002	50	40,000	0.001	0.002	40	40,000
R0.1	0.7	4.7	0.001	0.003	80	40,000	0.001	0.002	40	40,000	0.001	0.002	30	40,000
	0.3	1.5	0.005	0.005	300	40,000	0.003	0.003	200	40,000	0.003	0.003	150	40,000
	0.4	2	0.005	0.005	290	40,000	0.003	0.003	200	40,000	0.003	0.003	150	40,000
	0.5	2.5	0.005	0.005	280	40,000	0.003	0.003	180	40,000	0.003	0.003	130	40,000
	0.6	3	0.003	0.005	250	40,000	0.002	0.003	160	40,000	0.002	0.003	120	40,000
	0.75	3.75	0.003	0.005	200	40,000	0.002	0.003	150	40,000	0.002	0.003	110	40,000
	0.85	4.3	0.002	0.005	180	40,000	0.001	0.003	130	40,000	0.001	0.002	100	40,000
R0.15	1	5	0.002	0.003	160	40,000	0.001	0.002	120	40,000	0.001	0.002	90	40,000
	0.5	1.7	0.007	0.01	300	40,000	0.003	0.005	280	40,000	0.003	0.005	210	40,000
	0.6	2	0.005	0.007	300	40,000	0.003	0.005	250	40,000	0.003	0.005	180	40,000
	0.75	2.5	0.005	0.007	280	40,000	0.003	0.005	230	40,000	0.003	0.005	170	40,000
	1	3.3	0.005	0.007	250	40,000	0.003	0.005	200	40,000	0.003	0.005	150	40,000
	1.25	4.2	0.003	0.005	200	40,000	0.002	0.003	160	40,000	0.002	0.003	120	40,000
R0.2	1.5	5	0.003	0.005	180	40,000	0.002	0.003	120	40,000	0.002	0.003	90	40,000
	0.5	1.25	0.03	0.03	720	40,000	0.009	0.02	580	40,000	0.009	0.02	420	35,000
	0.65	1.6	0.025	0.03	720	40,000	0.009	0.02	580	40,000	0.009	0.02	420	35,000
	0.8	2	0.02	0.03	720	40,000	0.008	0.02	580	40,000	0.008	0.02	420	35,000
	1	2.5	0.02	0.03	720	40,000	0.008	0.02	580	40,000	0.008	0.02	400	35,000
	1.25	3.1	0.015	0.02	620	40,000	0.006	0.02	470	40,000	0.006	0.02	320	35,000
	1.5	3.75	0.01	0.02	500	40,000	0.005	0.01	400	40,000	0.005	0.01	280	35,000
	1.75	4.4	0.01	0.02	450	40,000	0.005	0.01	340	40,000	0.005	0.01	250	35,000
	2	5	0.007	0.01	380	40,000	0.005	0.007	300	40,000	0.005	0.007	220	35,000
R0.25	2.25	5.6	0.005	0.01	330	40,000	0.003	0.005	280	40,000	0.003	0.005	200	35,000
	2.5	6.25	0.005	0.007	300	40,000	0.003	0.005	260	40,000	0.003	0.005	190	35,000
	0.5	1	0.03	0.04	860	40,000	0.015	0.03	650	40,000	0.015	0.02	450	30,000
	1	2	0.02	0.03	860	40,000	0.01	0.02	650	35,000	0.01	0.02	450	30,000
	1.5	3	0.01	0.03	720	40,000	0.007	0.02	520	35,000	0.007	0.02	350	30,000
	2	4	0.01	0.02	650	40,000	0.007	0.01	400	35,000	0.007	0.01	270	30,000
	2.5	5	0.007	0.01	530	40,000	0.005	0.007	360	35,000	0.005	0.007	240	30,000
	3	6	0.007	0.01	420	35,000	0.005	0.007	320	35,000	0.005	0.007	220	30,000
R0.3	0.6	1	0.03	0.08	1,000	40,000	0.02	0.05	720	35,000	0.02	0.05	540	28,000
	1	1.7	0.03	0.06	1,000	40,000	0.02	0.05	720	30,000	0.02	0.05	540	25,000
	1.5	2.5	0.03	0.06	1,000	40,000	0.02	0.05	720	30,000	0.02	0.05	540	25,000
	2	3.3	0.03	0.06	1,000	40,000	0.02	0.05	720	30,000	0.02	0.05	540	25,000
	2.5	4.1	0.02	0.04	840	40,000	0.02	0.03	640	30,000	0.02	0.03	480	25,000
	3	5	0.02	0.04	840	40,000	0.02	0.03	600	30,000	0.02	0.03	450	25,000
	3.5	5.9	0.01	0.03	600	30,000	0.01	0.02	420	30,000	0.01	0.02	310	25,000
	4	6.7	0.01	0.03	600	30,000	0.01	0.02	420	30,000	0.01	0.02	310	25,000
R0.4	1	1.3	0.08	0.12	1,600	38,000	0.06	0.1	1,200	35,000	0.035	0.1	900	28,000
	2	2.5	0.07	0.1	1,600	35,000	0.05	0.1	1,200	30,000	0.03	0.1	900	25,000
	3	3.75	0.05	0.1	1,600	35,000	0.05	0.05	1,200	30,000	0.03	0.05	900	25,000
	4	5	0.04	0.06	1,200	30,000	0.03	0.05	860	25,000	0.02	0.05	640	20,000
	5	6.25	0.03	0.05	1,000	25,000	0.02	0.03	620	25,000	0.015	0.03	460	20,000

Recommended Conditions

Work Material			High Speed Steels/Hardened Steels SKH51·SKD11 (~62HRC)				High Speed Steels SKH55·HAP40 (~66HRC)				High Speed Steels SKH57·HAP72 (~70HRC)			
Radius	Under Neck Length	L/D	Depth of Cut		Feed	Spindle Speed	Depth of Cut		Feed	Spindle Speed	Depth of Cut		Feed	Spindle Speed
			a _p mm	a _e mm	mm/min	min ⁻¹	a _p mm	a _e mm	mm/min	min ⁻¹	a _p mm	a _e mm	mm/min	min ⁻¹
R0.5	1	1	0.1	0.2	2,000	30,000	0.08	0.12	1,400	25,000	0.05	0.12	1,000	20,000
	1.5	1.5	0.1	0.2	2,000	30,000	0.08	0.12	1,400	25,000	0.05	0.12	1,000	20,000
	2	2	0.1	0.2	2,000	30,000	0.08	0.1	1,400	25,000	0.05	0.1	1,000	20,000
	2.5	2.5	0.1	0.2	2,000	30,000	0.08	0.1	1,400	25,000	0.05	0.1	1,000	20,000
	3	3	0.1	0.2	2,000	30,000	0.08	0.1	1,400	25,000	0.05	0.1	1,000	20,000
	4	4	0.05	0.15	1,600	28,000	0.05	0.1	1,200	25,000	0.03	0.1	900	20,000
R0.6	5	5	0.04	0.1	1,400	25,000	0.03	0.05	920	20,000	0.02	0.05	700	16,000
	6	6	0.04	0.05	1,200	22,000	0.02	0.05	740	20,000	0.015	0.05	550	16,000
	2.4	2	0.1	0.2	2,000	30,000	0.08	0.1	1,600	25,000	0.05	0.1	1,200	20,000
	4	3.3	0.1	0.2	2,000	30,000	0.06	0.1	1,600	25,000	0.05	0.1	1,200	20,000
R0.75	6	5	0.05	0.1	1,400	25,000	0.03	0.07	1,000	20,000	0.02	0.07	750	16,000
	8	6.7	0.03	0.07	1,200	22,000	0.02	0.05	850	20,000	0.015	0.05	650	16,000
	2	1.3	0.1	0.3	2,500	30,000	0.1	0.2	2,000	25,000	0.06	0.2	1,500	20,000
	3	2	0.1	0.3	2,500	30,000	0.1	0.2	2,000	25,000	0.06	0.2	1,500	20,000
R0.8	4	2.7	0.1	0.3	2,000	25,000	0.1	0.2	1,600	22,000	0.06	0.2	1,200	18,000
	6	4	0.1	0.2	1,600	22,000	0.1	0.1	1,200	20,000	0.06	0.1	950	16,000
	8	5.3	0.05	0.2	1,400	20,000	0.05	0.1	1,000	18,000	0.03	0.1	700	13,000
R0.9	10	6.7	0.05	0.1	1,200	18,000	0.05	0.05	850	16,000	0.03	0.05	650	13,000
	8	5	0.07	0.2	1,400	20,000	0.05	0.1	1,000	16,000	0.03	0.1	750	13,000
	3	1.7	0.12	0.3	2,500	25,000	0.1	0.25	2,000	20,000	0.08	0.2	1,500	16,000
	4	2.2	0.12	0.25	2,500	25,000	0.1	0.2	1,800	20,000	0.08	0.2	1,500	16,000
	6	3.3	0.12	0.25	2,500	25,000	0.1	0.2	1,600	18,000	0.08	0.2	1,200	16,000
R1	8	4.4	0.08	0.2	2,300	23,000	0.08	0.15	1,400	17,000	0.06	0.1	750	13,000
	10	5.6	0.08	0.2	1,700	18,000	0.08	0.12	1,100	14,000	0.03	0.1	750	11,000
	2	1	0.2	0.5	2,500	25,000	0.15	0.3	2,000	20,000	0.1	0.3	1,500	16,000
	3	1.5	0.2	0.5	2,500	25,000	0.15	0.3	2,000	20,000	0.1	0.3	1,500	16,000
	4	2	0.2	0.5	2,500	25,000	0.15	0.3	2,000	20,000	0.1	0.3	1,500	16,000
	6	3	0.2	0.3	2,000	22,000	0.15	0.3	1,600	20,000	0.1	0.3	1,200	16,000
R1.25	8	4	0.1	0.2	1,600	18,000	0.1	0.15	1,200	16,000	0.06	0.15	950	13,000
	10	5	0.1	0.2	1,400	16,000	0.1	0.1	1,000	14,000	0.06	0.1	750	11,000
	12	6	0.07	0.1	1,200	14,000	0.05	0.1	850	12,000	0.03	0.1	650	9,500
	4	1.6	0.2	0.5	2,500	20,000	0.15	0.4	2,000	18,000	0.1	0.4	1,500	14,000
	6	2.4	0.2	0.5	2,500	20,000	0.15	0.4	2,000	18,000	0.1	0.4	1,500	14,000
R1.5	8	3.2	0.2	0.3	2,100	20,000	0.15	0.3	1,800	18,000	0.1	0.3	1,300	14,000
	10	4	0.15	0.2	1,800	18,000	0.1	0.15	1,500	16,000	0.06	0.15	1,100	13,000
	15	6	0.07	0.15	1,200	14,000	0.05	0.1	900	12,000	0.03	0.1	700	9,500
	6	2	0.2	0.6	2,500	18,000	0.2	0.5	2,000	15,000	0.12	0.5	1,500	12,000
	8	2.7	0.2	0.6	2,500	18,000	0.2	0.5	2,000	15,000	0.12	0.5	1,500	12,000
	10	3.3	0.2	0.4	2,100	18,000	0.15	0.3	1,800	15,000	0.1	0.3	1,300	12,000
	12	4	0.2	0.4	2,000	18,000	0.1	0.3	1,500	15,000	0.06	0.3	1,100	12,000
	14	4.7	0.1	0.3	1,600	16,000	0.1	0.2	1,200	12,000	0.06	0.2	900	10,000
R2	16	5.3	0.1	0.3	1,600	16,000	0.1	0.2	1,200	12,000	0.06	0.2	900	10,000
	18	6	0.1	0.2	1,400	16,000	0.1	0.15	960	12,000	0.06	0.15	750	9,500
	20	6.7	0.08	0.2	1,200	14,000	0.08	0.1	850	12,000	0.06	0.1	650	9,500
	8	2	0.2	0.8	2,500	15,000	0.2	0.6	2,000	12,000	0.15	0.6	1,500	9,500
	10	2.5	0.2	0.8	2,500	15,000	0.2	0.6	2,000	12,000	0.15	0.6	1,500	9,500
	12	3	0.2	0.8	2,500	15,000	0.2	0.6	2,000	12,000	0.15	0.6	1,500	9,500
R2.5	15	3.75	0.2	0.8	2,000	15,000	0.15	0.6	1,600	12,000	0.12	0.6	1,200	9,500
	20	5	0.1	0.6	1,700	14,000	0.1	0.4	1,200	10,000	0.08	0.4	900	8,000
	25	6.25	0.1	0.4	1,200	14,000	0.1	0.2	850	10,000	0.08	0.2	650	8,000
	10	2	0.2	1.2	2,500	12,000	0.2	0.7	2,000	10,000	0.15	0.7	1,500	8,000
	15	3	0.2	1.2	2,500	12,000	0.2	0.7	2,000	10,000	0.15	0.7	1,500	8,000
	20	4	0.2	1	2,000	10,000	0.15	0.6	1,600	8,500	0.12	0.6	1,200	6,500

Work Material			High Speed Steels/Hardened Steels SKH51·SKD11 (~62HRC)				High Speed Steels SKH55·HAP40 (~66HRC)				High Speed Steels SKH57·HAP72 (~70HRC)			
Radius	Under Neck Length	L/D	Depth of Cut		Feed	Spindle Speed	Depth of Cut		Feed	Spindle Speed	Depth of Cut		Feed	Spindle Speed
			ap mm	ae mm			ap mm	ae mm			ap mm	ae mm		
R2.5	25	5	0.15	0.8	1,800	8,600	0.1	0.3	1,200	7,200	0.08	0.3	1,000	6,500
	30	6	0.15	0.5	1,500	7,600	0.1	0.2	860	6,400	0.08	0.2	750	6,000
R3	10	1.7	0.3	1.2	2,500	8,000	0.2	1	2,000	7,000	0.15	1	1,500	5,500
	15	2.5	0.3	1.2	2,500	8,000	0.2	1	2,000	7,000	0.15	1	1,500	5,500
	20	3.3	0.3	1.2	2,500	8,000	0.2	1	2,000	7,000	0.15	1	1,500	5,500
	25	4.1	0.2	1	2,200	8,000	0.15	0.7	1,600	7,000	0.12	0.7	1,200	5,500
	30	5	0.2	1	1,800	7,000	0.15	0.7	1,300	6,500	0.12	0.7	950	5,000
	35	5.8	0.17	0.8	1,600	6,800	0.12	0.5	1,200	5,800	0.1	0.5	800	4,500
	40	6.7	0.15	0.6	1,200	6,400	0.1	0.4	1,000	5,200	0.08	0.4	650	4,000
Notes			※1 Depth of Cut ap indicates Axial Depth of Cut, ae indicates Radial Depth of Cut. ※2 In case of chattering etc., please adjust cutting conditions if necessary. ※3 At point where cutting load is high such as at corners, pay attention to setting cutting conditions and tool paths particularly. ※4 Adjust both spindle speed and feed at the same rate. ※5 A shrink fit type is recommended for tool holder. When using collet type or others, strictly adhere to minimum gripping length. ※6 We recommend using oil mist coolant.											

Comparison of dimensional accuracy

HAP72 (70HRC)

Comparison of dimensional accuracy after finishing

Tool : MRBSH230SF R1×6

Cutting content: Finishing for 1 pocket

Cutting time : 32min/per pocket

Tool path : Contour line finishing (Side)

Scanning line finishing (Bottom)

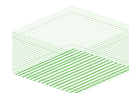

Finishing

$n = 16,000 \text{ min}^{-1}$, $V_f = 1,000 \text{ mm/min}$, $a_p 0.03 \times a_e 0.03 \text{ mm}$, Oil Mist

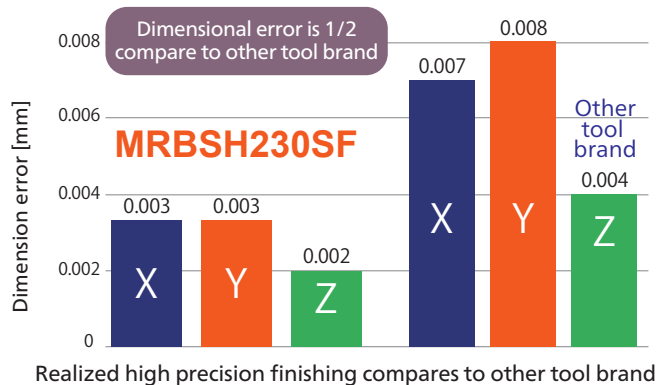
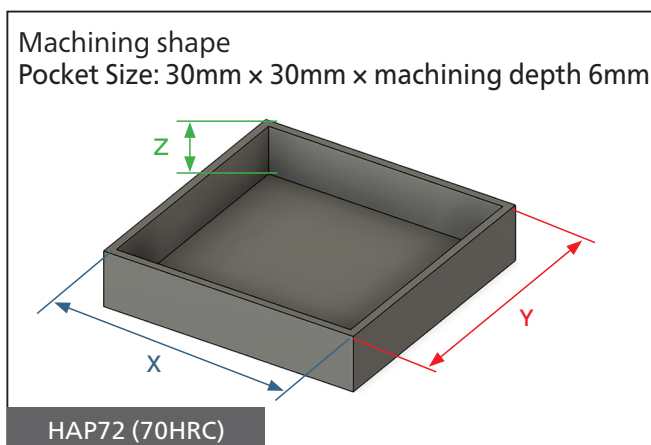

Machining Case 1

HAP72 (68HRC) 3 difference shape on screw head (punch sample)

Realize high precision even machining on 68HRC hardened steel

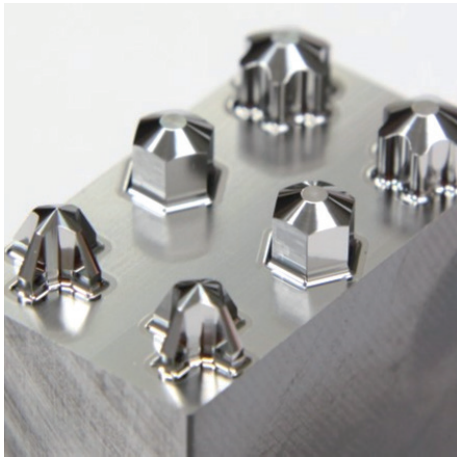

Work Material : HAP72 (68HRC)
 Coolant : Oil mist
 Total machining time : 8hr 25min
 Work size : 20×35mm
 Machining depth : 5.1mm

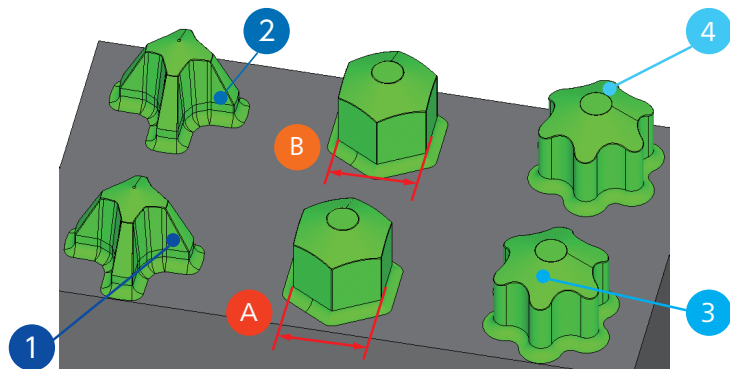

Surface Roughness

Unit [μm]		
Measuring position	Ra	Rz
1 At the beginning	0.176	1.320
2 At the end	0.155	1.125
3 At the beginning	0.114	0.963
4 At the end	0.142	0.877

Accuracy

Unit [mm]				
Measuring position	Target	Actual	Error	Deflection
A At the beginning	5.080	5.087	0.007	under 0.001
B At the end	5.080	5.090	0.010	0.001

Process	Roughing	Semi-finishing Side & Finishing Bottom	Stock	Finishing
Tool	MRBSH230SF R1×4	MRBSH230SF R1×4	MRBSH230SF R0.5×4	MRBSH230SF R0.5×4
Spindle speed [min^{-1}]	16,000		18,000	
Feed [mm/min]	1,500	600	300	400
Depth of cut $a_p \times a_e$ [mm]	0.1 × 0.3	pf : 0.03	pf : 0.03	pf : 0.02
Stock [mm]	0.015	Side 0.01 Bottom —	0.01	—
Machining time	181 min	95 min	80 min	149 min

※ pf : pick feed

Machining Case 2

HAP40 (65HRC) Gear shape punch mold

High precision even during long finishing over 4 hours



Material : HAP40 (65HRC)

Coolant : Oil mist

Total machining time : 8hr 46min

Work size : Φ 25x50mm Machining depth : 6mm

Surface Roughness

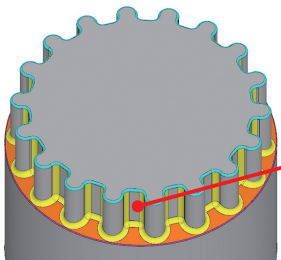

Unit [μ m]	
Measuring position	Side
Ra	0.031
Rz	0.225

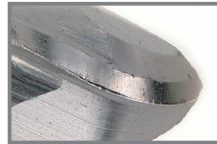

R edge retreat amount
0.003mm after side finishing
for 2 hours

Accuracy

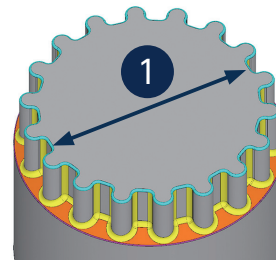

Unit [mm]	
Measuring position	1
Target	20.644
Actual	20.647
Error	0.003

Tool wear

Process	Roughing	Stock removal	Semi-finishing	Finishing
Tool	MRBSH230SF R1x6	MRBSH230SF R0.5x5	MRBSH230SF R0.5x5	MRBSH230SF R0.5x5
Rake side				
Peripheral cutting edge				
R end cutting edge				
Spindle speed [min^{-1}]	20,000			12,000
Feed [mm/min]	1,600	920	920	460
Depth of cut [mm] $a_p \times a_e$	0.15 x 0.3	0.03x0.1	Side face: 0.03x0.02 Surface: 0.02x0.05	pf : 0.015
Stock [mm]	0.03		0.01	—
Machining time	24 min	3hr 8min	1hr 8min	4hr 6min

Machining Case 3

YXR3 (61HRC) Fine Branking Sample

Machining accuracy achieved by high R accuracy of $\pm 3\mu\text{m}$



Material : YXR3 (61HRC)
 Coolant : Oil mist
 Total machining time : 7hr 27min
 Work size : 60x60mm
 Cutting depth : 4mm

※Total machining time includes WEDM process (white part) both blank holder part and die part

Surface Roughness

Accuracy

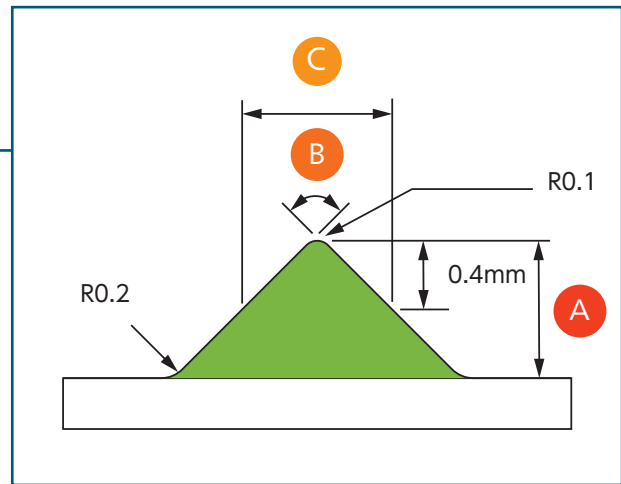
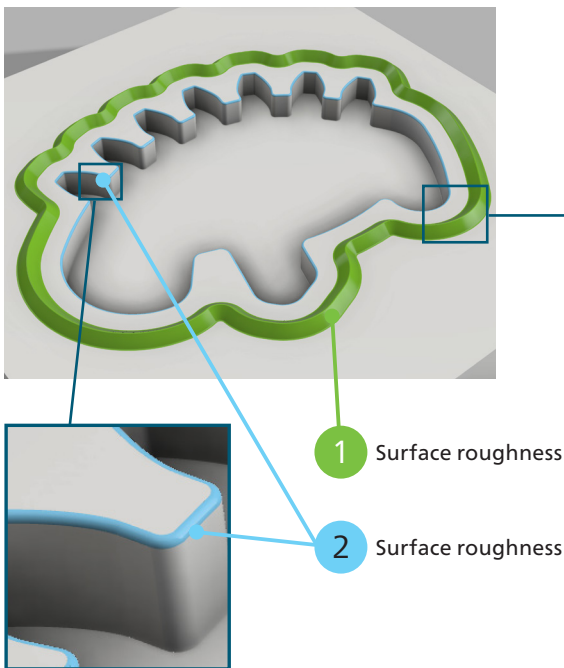

Unit [μm]

Measuring position	1	2
Tool	MRBSH230SF R0.5x2	MRBSH230SF R0.2x1
Ra	0.145	0.080
Rz	1.192	0.521

Measuring position	A	B	C
Target	0.958mm	90°0'00"	0.883mm
Actual	0.958mm	90°15'10"	0.888mm
Error	0.000mm	0°15'10"	0.005mm

Blank holder

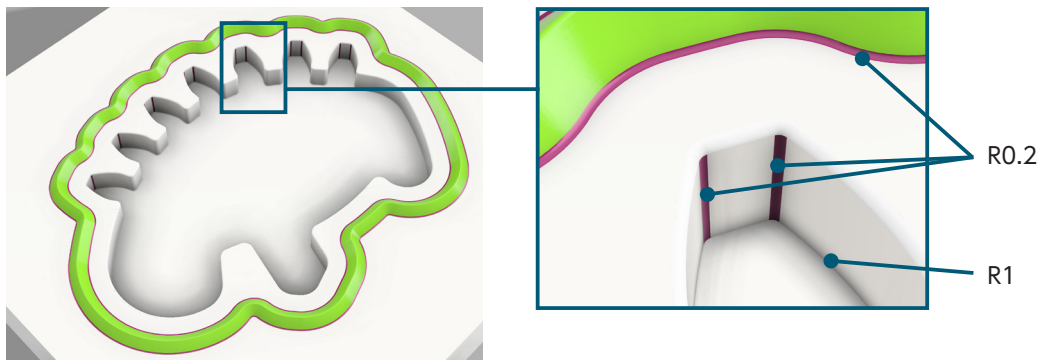

Process	Roughing	Semi-finishing	Finishing	Stock	Finishing	Stock	Stock
Tool	MRBSH230SF R1x4	MRBSH230SF R1x4		MRBSH230SF R0.5x2		MRBSH230SF R0.25x1.5	MRBSH230SF R0.2x1
Spindle speed [min ⁻¹]	25,000			30,000			
Feed [mm/min]	2,500			1,000		540	540
Depth of cut [mm]	0.2 x 0.5	pf : 0.05	pf : 0.08	pf : 0.05	pf : 0.03	pf : 0.03	pf : 0.02
Stock [mm]	0.03	0.01	-	0.01	- (Only corner part 0.005)		-
Machining time	39 min	40 min	1hr 6min	1hr 3min		47 min	1hr 26min

※ pf : pick feed

Die

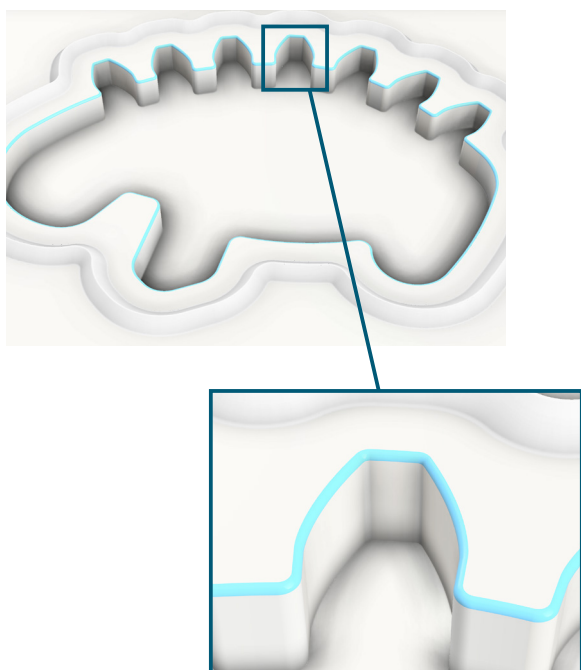

Process	Roughing	Finishing
Tool	MRBSH230SF R0.25x1.5	MRBSH230SF R0.2x1
Spindle speed [min ⁻¹]	30,000	
Feed [mm/min]	540	
Depth of cut [mm] ap x ae	0.01 x 0.03	pf : 0.01
Stock [mm]	0.003	-
Machining time	1hr 11min	35 min

※ pf : pick feed

NS TOOL CO.,LTD.

www.ns-tool.com
6F., Sumitomo Fudosan Oimachi Ekimae Bldg.,
1-28-1 Oi, Shinagawa-ku, Tokyo 140-0014, Japan
TEL. +81-3-3774-2459 FAX. +81-3-3774-2460

NS TOOL USA, INC.

us.ns-tool.com
2265 Building # 3, Star CT.,
Rochester Hills, MI 48309, USA
TEL. +1-248-829-1960



CAUTION

Attention on Safety

- 1) When removing tools from cases, be careful of getting-out of tools and don't touch directly the cutting edges.
- 2) Never touch the cutting edges directly with bare hand.
- 3) Use safety covers and eye protection, as tools may be broken.
- 4) Use holders, etc. that match the tools and nature of the processing operations. The tool should be firmly attached to the holder to prevent shaking.
- 5) The work materials clamp firmly.
- 6) Make sure of dimensions of tools and work pieces before starting operation.
- 7) It is necessary to adjust conditions according to the dimensions of work materials and the machine.
- 8) Select a cutting fluid appropriate to the particular usage. Using a non-water cutting fluid could lead to fires due to sparks generated during processing or heat caused by breakage. Ensure that you take proper fire-prevention measures.
- 9) If abnormal sound, etc. occurs during processing, stop the machine immediately.
- 10) Don't modify tools.

000

23'12



Specifications may change without notice for improvement.